

Smart VENDING MACHINE

III T milliontech

Interactive Vending Machine



SV-4923

Smart VENDING MACHINE

Product Features



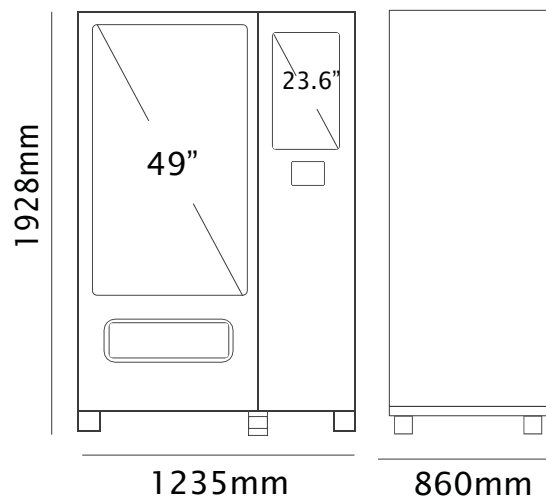













- **49" Touch Display**
 - 23.6" advertising LCD display
 - Size: 1235x860x1928(WxDxH mm)
 - Weight: 380kg
 - Max. Capacity: 540 stocks in 6 layers
 - Power Supply: 220VAC 320W
- **Interactive POS System**
- **Online sales monitoring**, statistical reports
- **Octopus Payment System** or other options
- **Cooling and heating system** from 4°C to +20°C



Smart Vending Machine For Marketing Event

Innovative Software for Smart Vending Machine

Software Functions

 Advertising Display Platform	 Provide Smooth Operation	 Alert System	 Generate Daily Reports
 Top Screen Video Resolution:1080x436px	 Remote Monitoring	 Send E-mail Alert to staff	 Sales Report
 Bottom Banner Resolution: 1080x436px	 Sales & Inventory Data Sync to Server	 Online Stock inventory Alert	 Stock Inventory Report
 Product LCD Display: 23.6"	 Easy Stock Replenishment	 Machine Maintenance	 Octopus Transaction Report

Multiple Solutions

Interactive Advertising

Instant Shopping

Item Selling

Ticketing

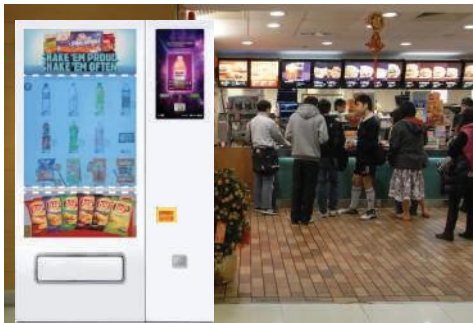

Restaurant

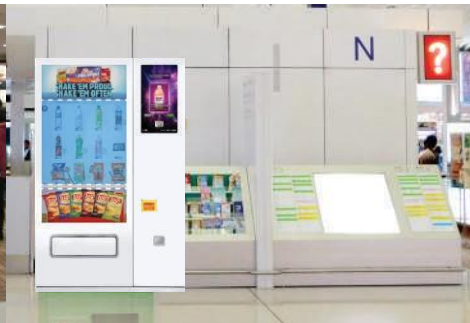

Airport



Convenient Store



Lobby



Shopping Mall



Gymnasium



Commercial Building/Area

- Cinema
- Gymnasium
- Shopping Mall
- Convenient Store



Public Transportation Area

- Airport
- MTR Station
- Bus Stop
- Ferry Pier



Educational Institutions

- Campus
- Canteen
- Dormitory



Hotel & Catering

- Hotel Lobby
- Restaurant
- Food Court



Residential Area

- Lobby
- Club House

Contact Us: If you have further enquiries, please contact us for more information & discussion.

Million Tech Development Limited

Address: Unit 509, 5/F, Tower II, Cheung Sha Wan Plaza, 833 Cheung Sha Wan Road, Kowloon, Hong Kong

General Line: (852) 2788 3306

Fax: (852) 2319 2967

Website: <https://milliontech.com>

Sales Enquiry: (852) 2784 2868

Email: sales@milliontech.com

Service Hotline: (852) 2784 2888

Email: helpdesk@milliontech.com

