

Smart VENDING MACHINE

Cloud-Based interactive Vending Machine

III T milliontech



SV-4923

Smart VENDING MACHINE

Product Features



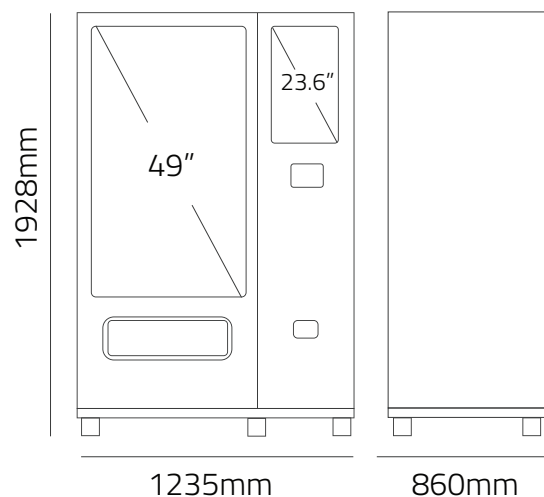









- **49" Capacitive Touch Display**
 - 23.6" advertising LCD display
 - Size: 1235 x 860 x 1928 (W x D x H, mm)
 - Weight: 380kg
 - Max. Capacity: 540 stocks in 6 layers
 - Power Supply: 220VAC 320W
- **Interactive POS System:** tailor-made interface
- Make **online sales monitoring**, statistical reports
- **Octopus Payment** System or other options
- Cooling and heating system from 4 °C to +20 °C



Smart Vending Machine For Marketing Event





Innovative Software tailor-made for Smart Vending Machine

Software Functions

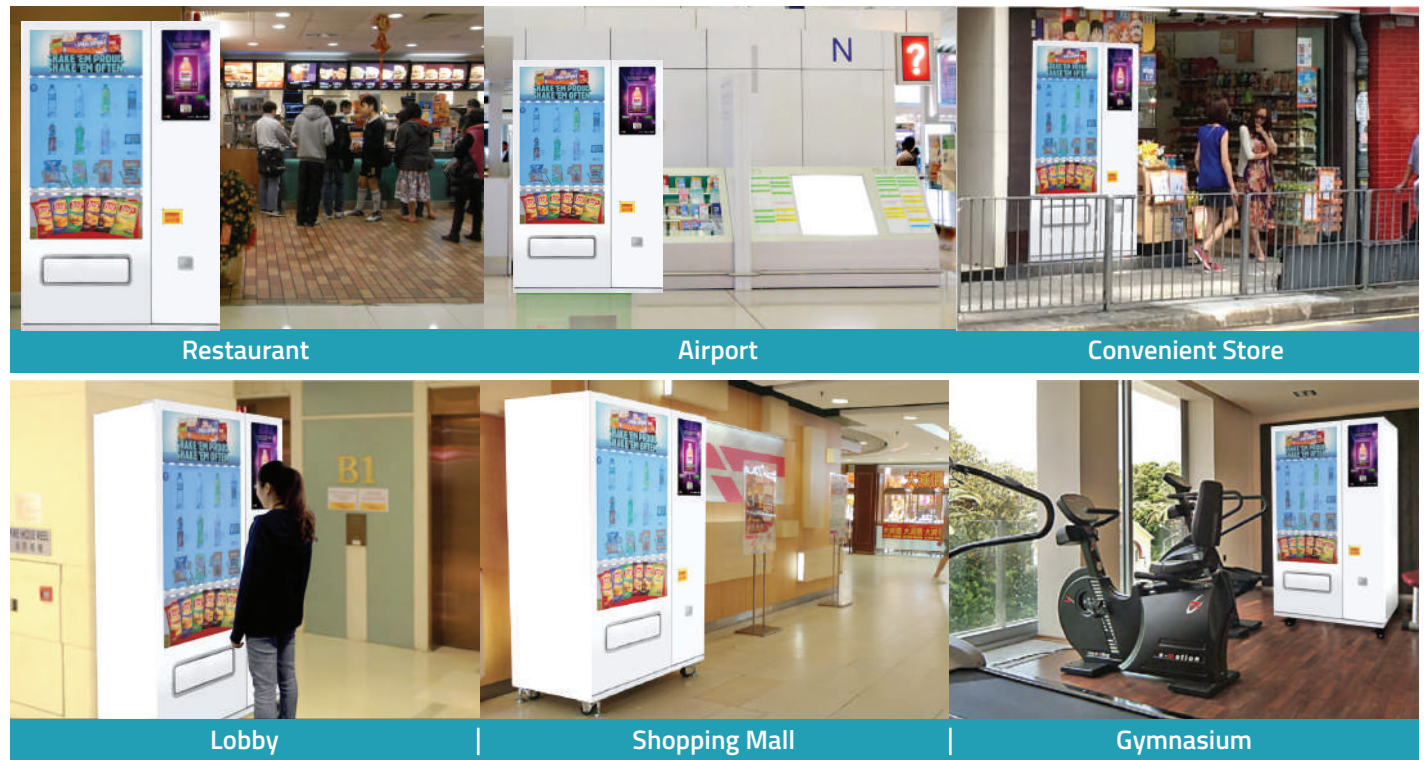
Advertising Display Platform	Provide Smooth Operation	Alert System	Generate Daily Reports
 Upper Video Resolution: 1080x436px  Bottom Banner Resolution: 1080x436px  Product LCD Display: 23.6"	 Interactive Contact to system  Data can be transferred to internal server  Easy Stock Replenishment	 Send E-mail Alert to staff  Online Stock inventory Alert  Machine Maintenance	 Sales Update Report  Stock Inventory Report  Octopus Transaction Report

Multiple Solutions Interactive Advertising Instant Shopping Item Selling Ticketing



 <p>Commercial Building/Area</p> <ul style="list-style-type: none"> • Cinema • Gymnasium • Shopping Mall • Convenient Store 	 <p>Public Transportation Area</p> <ul style="list-style-type: none"> • Airport • MTR Station • Bus Stop • Ferry Pier 	 <p>Educational Institutions</p> <ul style="list-style-type: none"> • Campus • Canteen • Dormitory 	 <p>Hotel & Catering</p> <ul style="list-style-type: none"> • Hotel Lobby • Restaurant • Food Court 	 <p>Residential Area</p> <ul style="list-style-type: none"> • Lobby • Club House
-----------------------------------------------------------------------------------------------------------------------------------------------------------------------------------------------------------------------------------------------------------------	-----------------------------------------------------------------------------------------------------------------------------------------------------------------------------------------------------------------------------------------------------------	-------------------------------------------------------------------------------------------------------------------------------------------------------------------------------------------------------------------------------	--------------------------------------------------------------------------------------------------------------------------------------------------------------------------------------------------------------------------------------	------------------------------------------------------------------------------------------------------------------------------------------------------------------------------------------------------

Contact Us: If you have further enquiries, please contact us for more information & discussion.

Million Tech Development Limited



Address: Unit 509, 5/F, Tower II, Cheung Sha Wan Plaza, 833 Cheung Sha Wan Road, Kowloon, Hong Kong

General Line: (852) 2788 3306

Sales Enquiry: (852) 2784 2868

Service Hotline: (852) 2784 2888

F a x : (852) 2319 2967

Email: sales@milliontech.com

Email: helpdesk@milliontech.com

Website: <https://milliontech.com>